

THIS COPY IS PROVIDED ON A RESTRICTED BASIS AND IS NOT TO BE USED IN ANY WAY DETRIMENTAL TO THE INTERESTS OF PANDUIT CORP.

Material	High Conductivity Seamless Copper Tube
Plating	Electro-Tin
Wire Size	1/0 AWG
Wire Type	Stranded Copper; Class B: Compact, Compressed or Concentric, Class C: Concentric
Wire Strip Length	1-1/2 in.
Stud Size	1/2 in.
UL Listed Wire Connector	Yes, for applications up to 35kv. Consult cable manufacturer for voltage stress relief instructions with applications greater than 2000 volts.
UL Temperature Rating	90° C
C.S.A Certified Wire Connector	Yes
Panduit Color Code on Barrel	PINK
Panduit Die Index No. on Barrel	P42
Alternate Industry Die Index No. () on Barrel	(12)

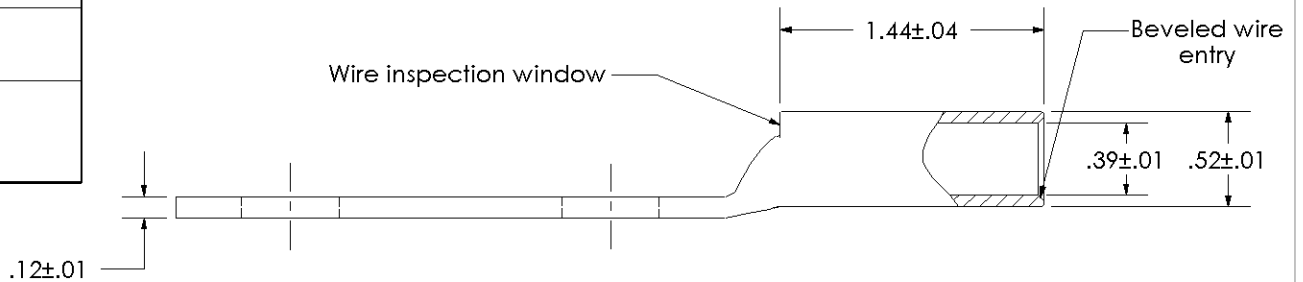
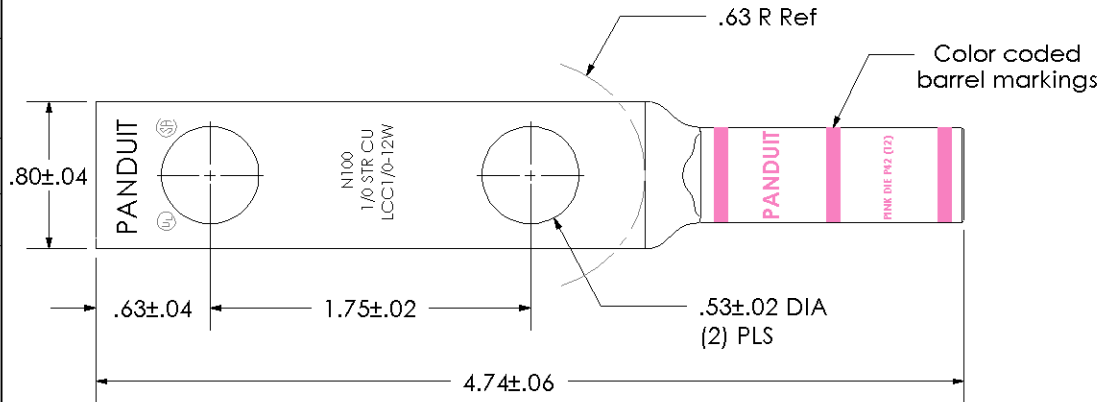

PANDUIT CORP. TINLEY PARK, ILLINOIS

LCC1/0-12W-X
Copper Lug - Two-Hole, Long Barrel with Window

00	9/02	SAB	DRL	RELEASED	10340
REV	DATE	BY	CHK	DESCRIPTION	ECN

SCALE N/A DRAWING NO / CAD FILE LCC1_0-12W-CUST